

# HCS65-1-x Amplifier

A product of DKT family

## Quick Start Guide

1



Instruction video



Technical information on DKT HCSx-Amplifier

2

### Package Contents

1 pieces



HCS65-1-x Amplifier

1 pieces



Power Supply

1 pieces

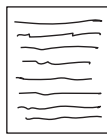

Quick Start Guide

3

### Overview HCS65-1-x

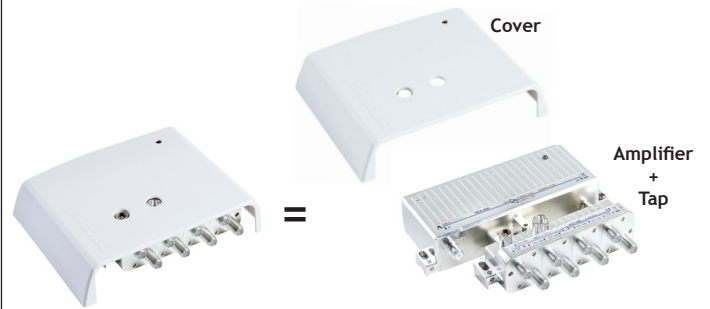

4

### Product overview

Type No.	Item No.	Description
HCS65-1-4	46256	4+1 way tap 87.5-1006 MHz: 8-12 dB 5-65 MHz: 2.5 dB
HCS65-1-8	46258	8+1 way tap 87.5-1006 MHz: 5.5-9.5 dB 5-65 MHz: 0 dB

5

### You need



11mm combination wrench



screwdriver

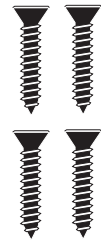

screws

6

### Removing the cover

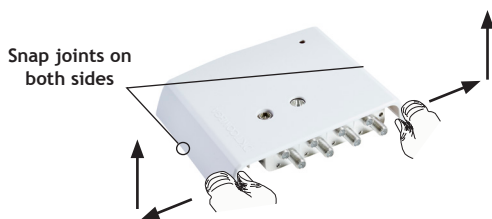

7

### Overview Amplifier and Tap

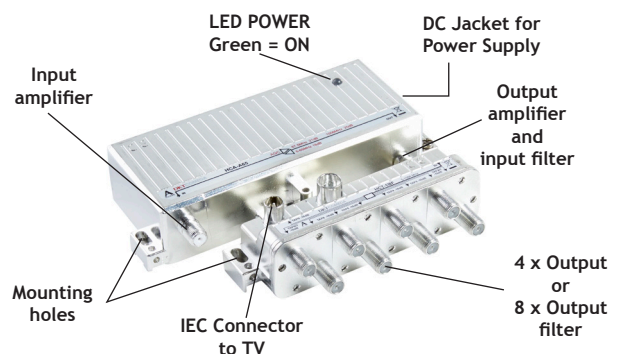

8

## Mounting instructions

Mount the amplifier and filter on the wall with 4 screws.  
(take height for outgoing cables)

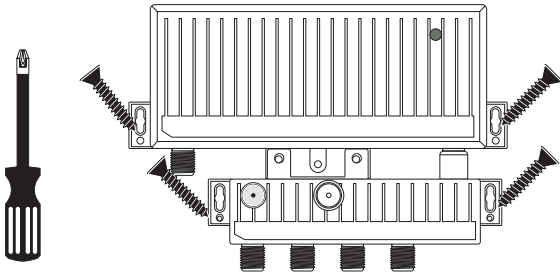

9

## Connection instructions

Incoming  
coaxial cable  
from operator

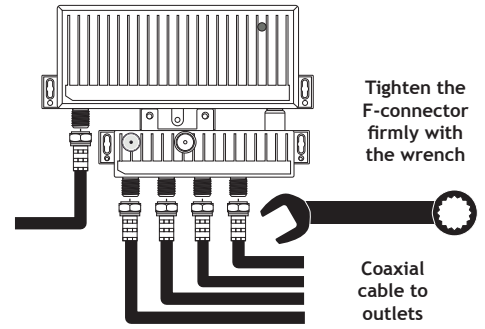

Tighten the  
F-connector  
firmly with  
the wrench

Coaxial  
cable to  
outlets

10

## Schematic connection

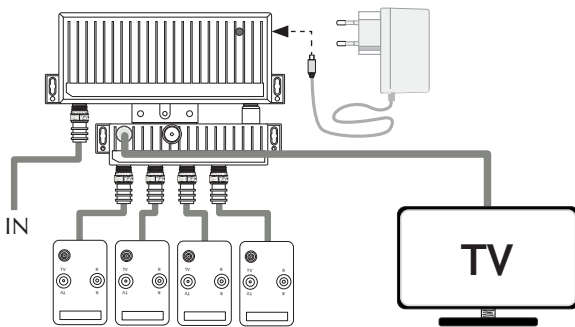

11

## Remounting cover

Press down  
the cover to it  
snaps

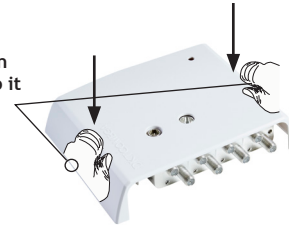

12

## HCS65-1-4 with 4 outlets

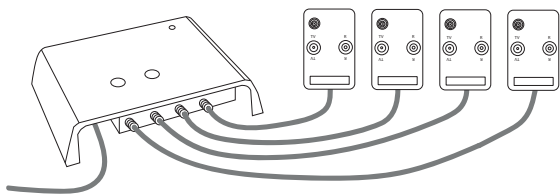

13

## HCS65-1-8 with 8 outlets

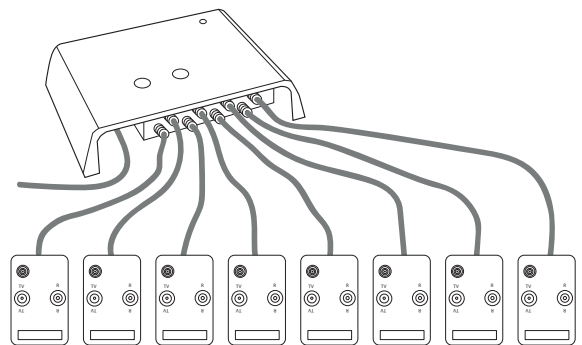

14

## Configuration

As the amplifier has Automatic Gain Control (AGC) there are no need for configuration.

The AGC ensures that you cannot override the amplifiers specification and distortion the signal.

15

For further information and troubleshooting  
please visit our web site

[www.dktcomega.com](http://www.dktcomega.com)



16